

"Schutzvermerk nach DIN ISO 16016 beachten" "Please pay attention to copyright note DIN ISO 16016"

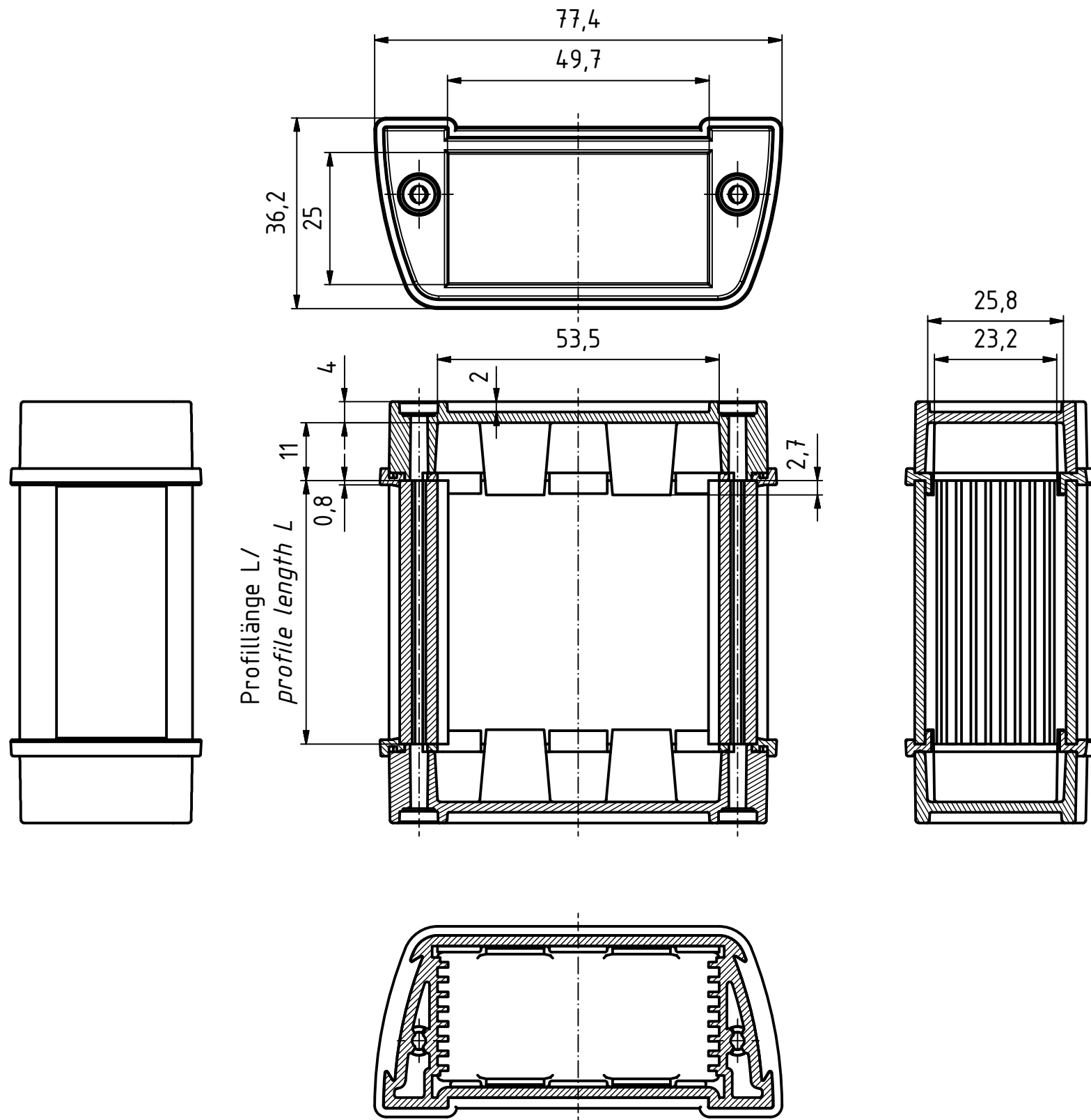

Maßstab/ Scale: 1:1

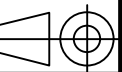

Zeichnungs-Nr. / Drawing-No.:  
3K 5365.111.01

Artikel / Article:  
AluStyle  
ASD 830

Katalogzeichnung/Catalogue drawing

Ä.Nr/  
Alt.No:

Datum/  
Date:



A Phoenix Mecano Company

DISK: 2802947.idw  
Datum/Date: 22.04.2008 HR