

"Schutzvermerk nach DIN ISO 16016 beachten" "Please pay attention to copyright note DIN ISO 16016"

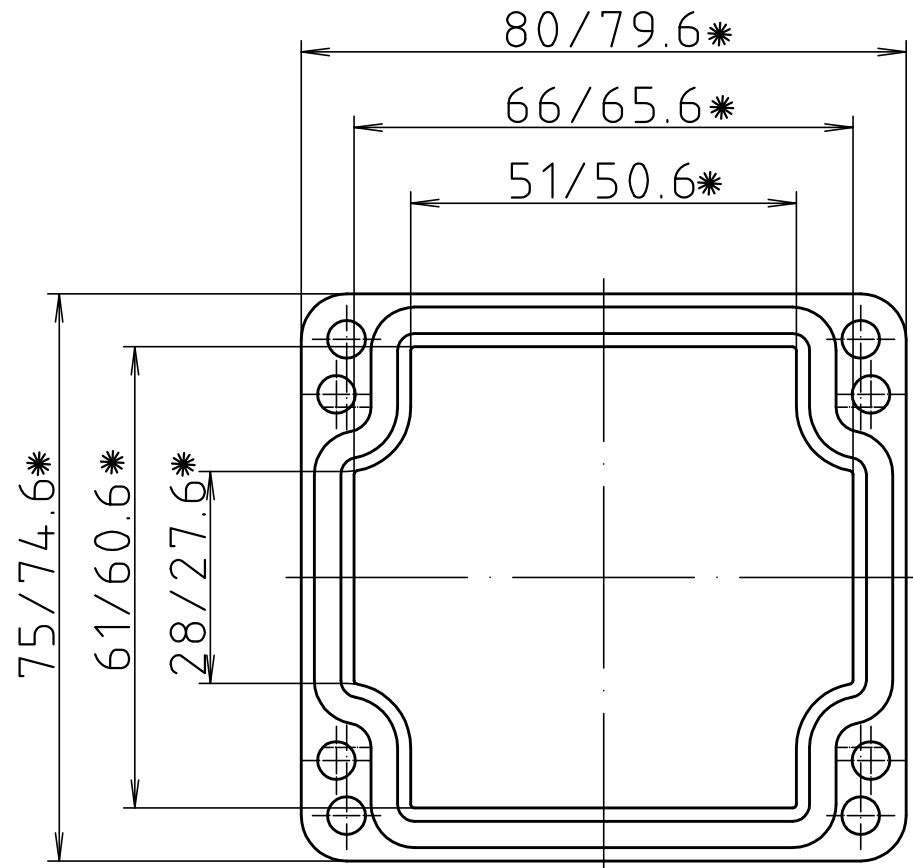

Deckel/
lid

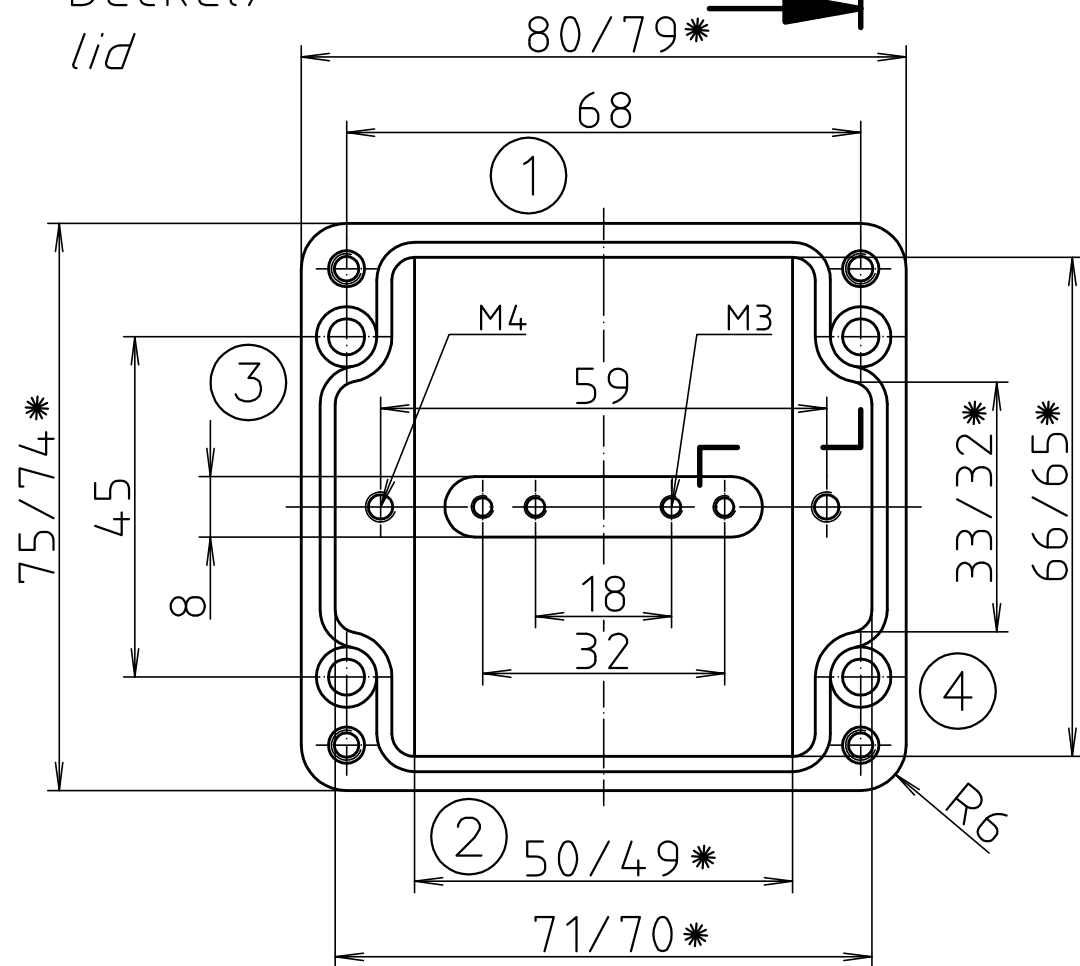

Unterteil/
base

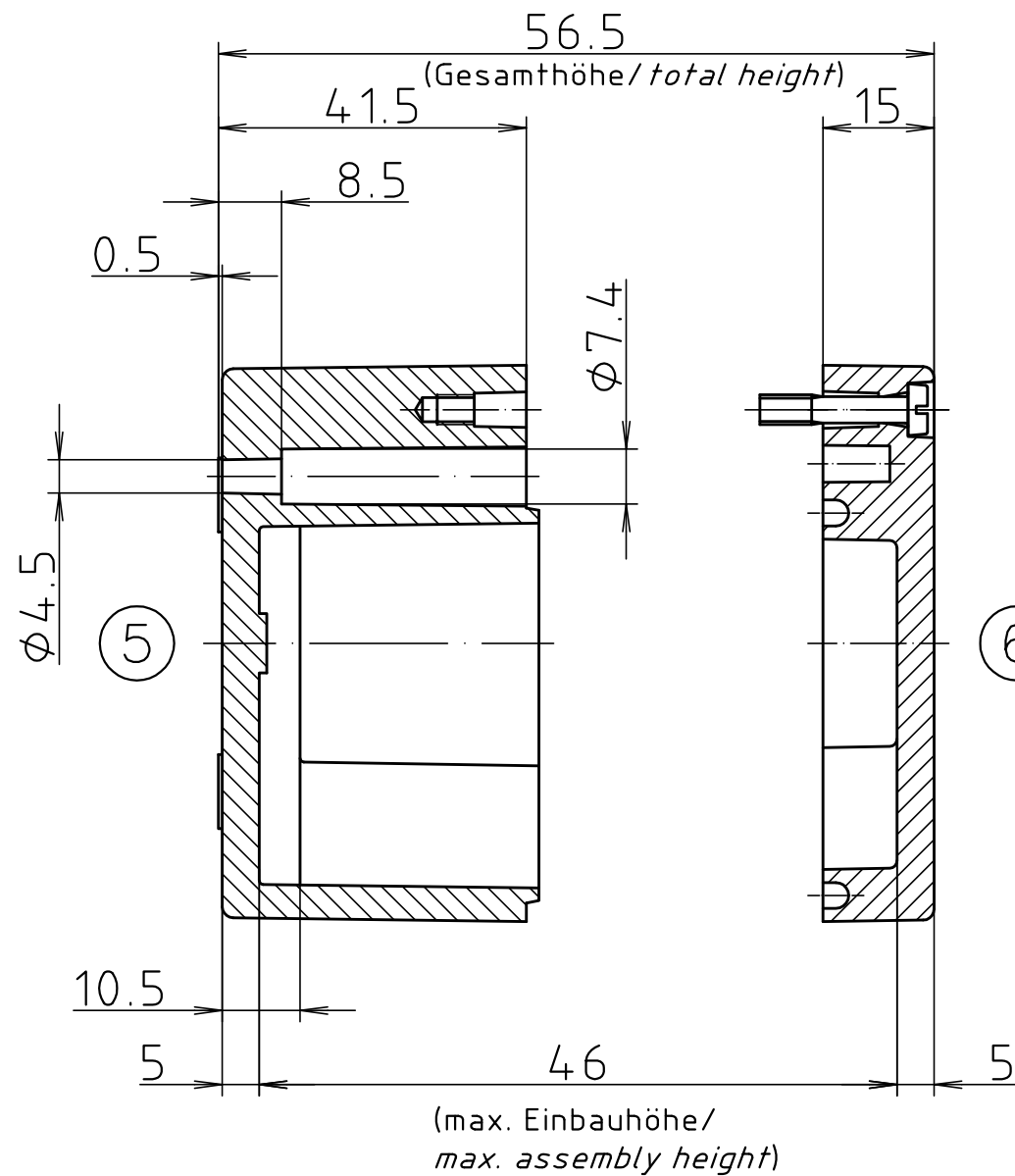

* = Mass durch Formkonizität nach unten verringert.
Freimaß-Toleranz nach DIN 16901-130/
Dimension reduced at bottom due to conical form.
Tolerances to DIN 16901-130.

Maßstab/ Scale: 1:1		
Zeichnungs-Nr. / Drawing-No.: 3K 0305.004.01		
Artikel / Article: P 305 / 2 0808 06 Katalogzeichnung/ Catalogue drawing		
A.Nr./ Alt-No.:	Datum/ Date:	
DISK: 2 401 753		
Datum/Date: 29.03.2004 NK		

