

Ausführung E 410 F/
Version E 410 F

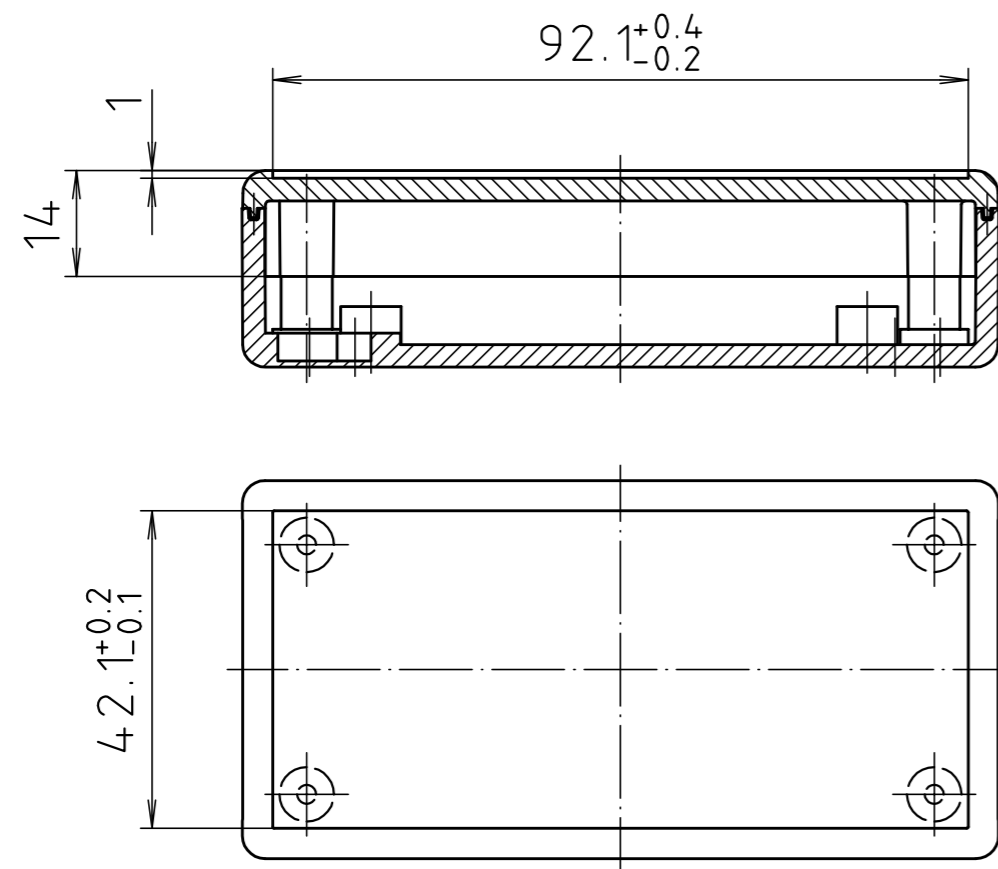

Ausführung E 410 FVL/
Version E 410 FVL

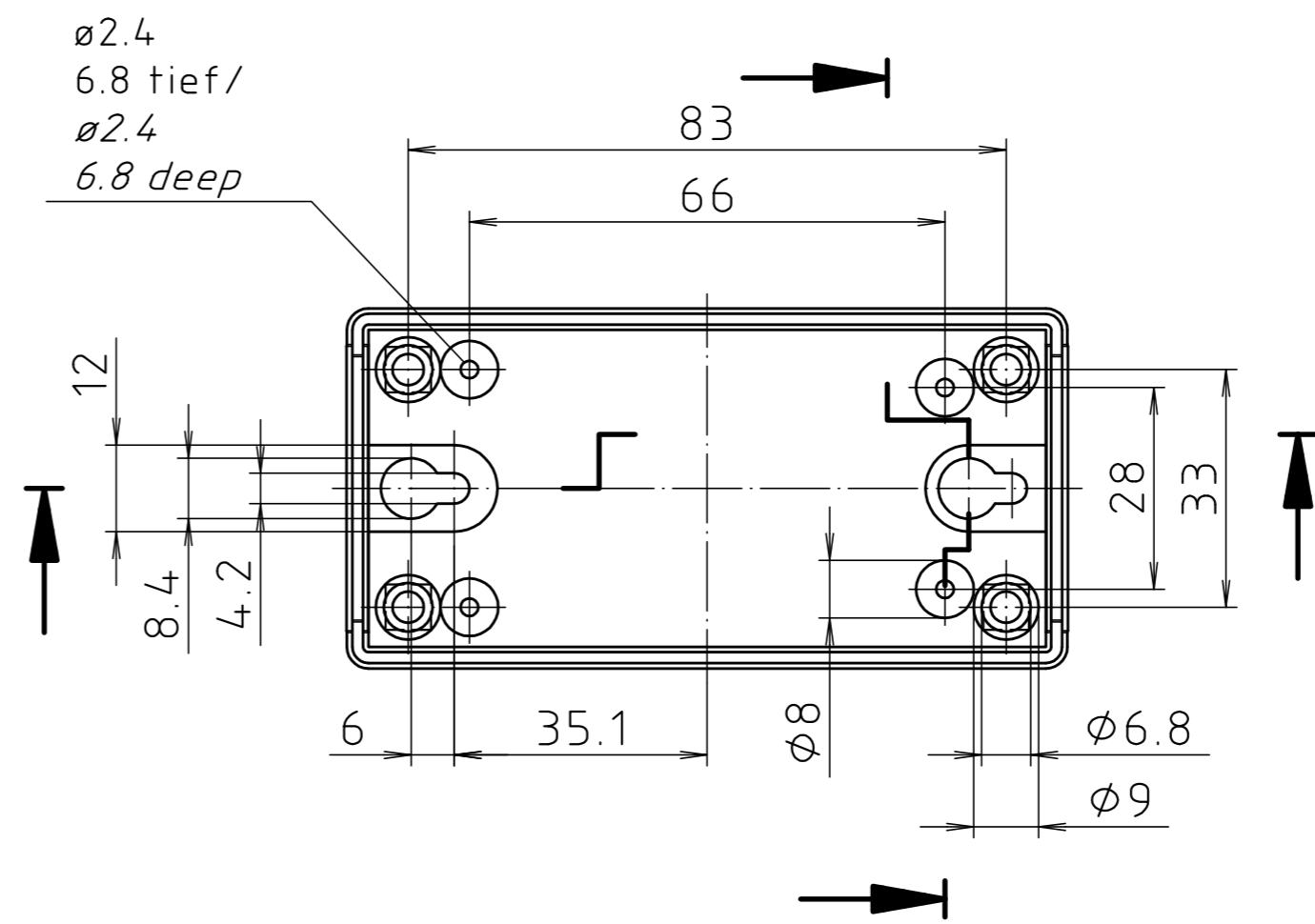
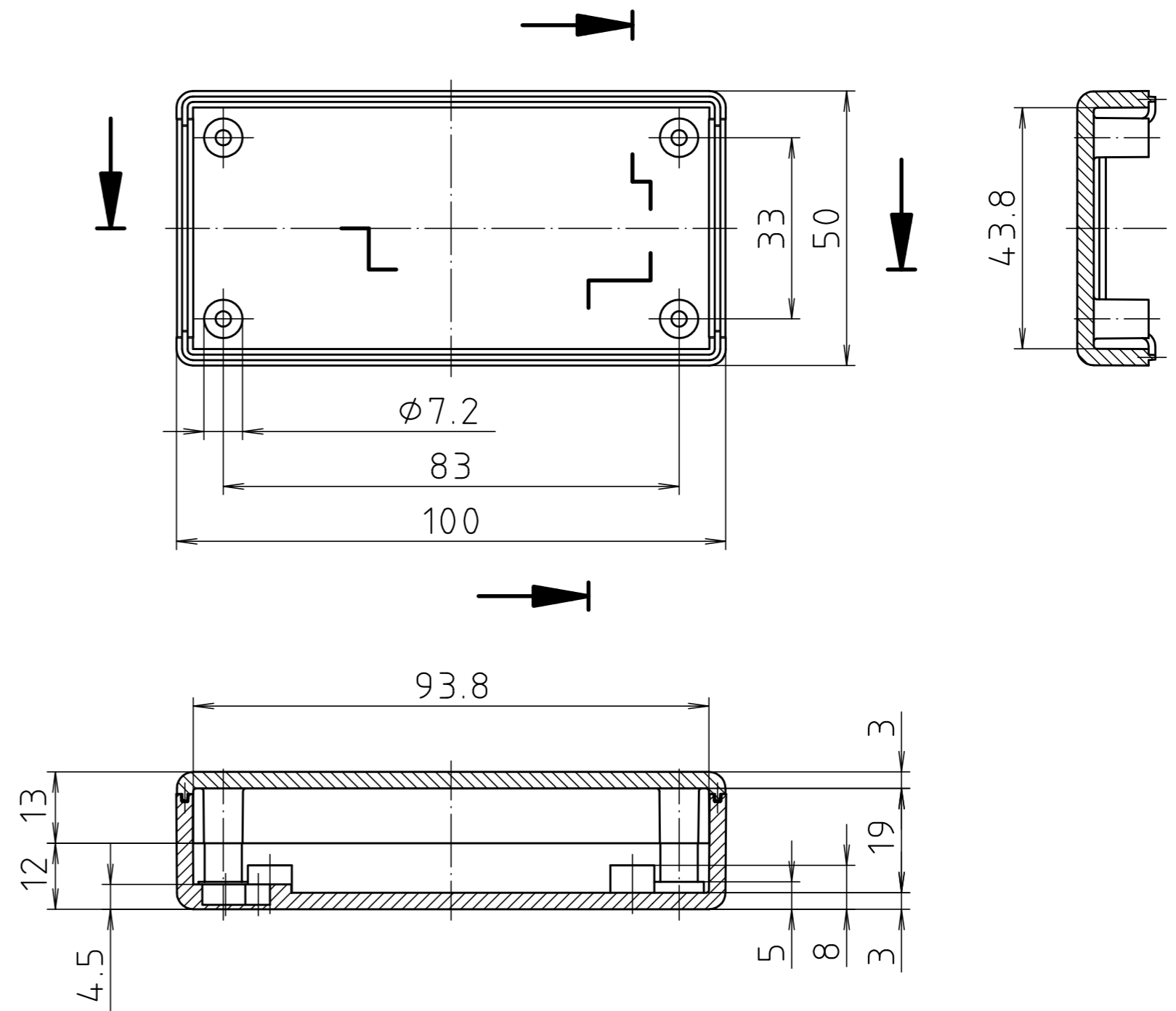
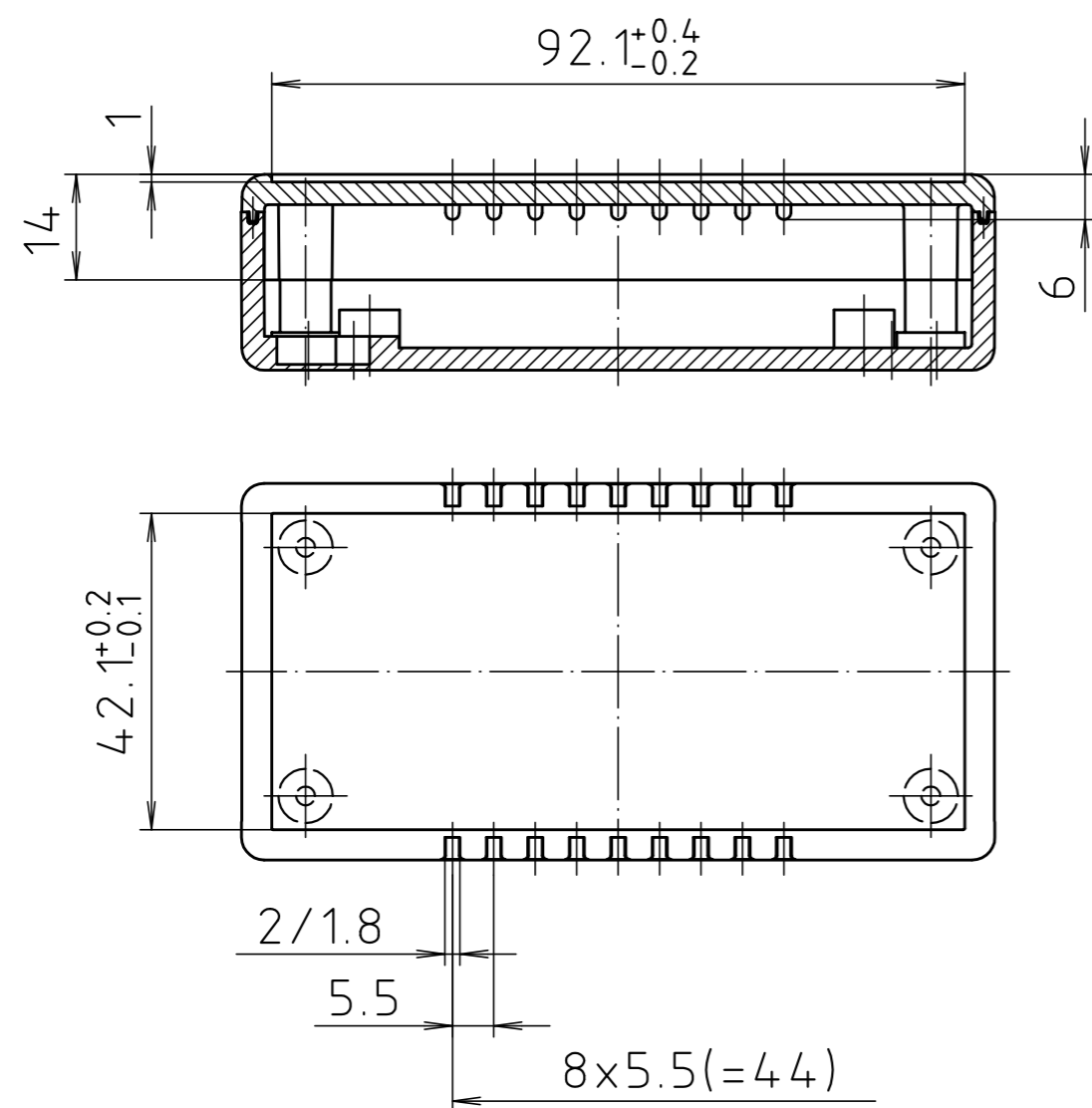

Maßstab/ Scale: 1:1		
Zeichnungs-Nr. / Drawing-No.: 2K 410.027.02		
Artikel / Article: E 410 (F) (FVL) Katalogzeichnung/ Catalogue drawing		
3622	08.08.2002	
A.Nr./ Alt-No.:	Datum/ Date:	
DISK: 2 801 042		
Datum/Date: 10.08.93 OK		

"Schutzvermerk nach DIN ISO 16016 beachten." "Please pay attention to copyright note DIN ISO 16016"