

Schutzvermerk nach DIN ISO 16016 beachten. "Please pay attention to copyright note DIN ISO 16016"

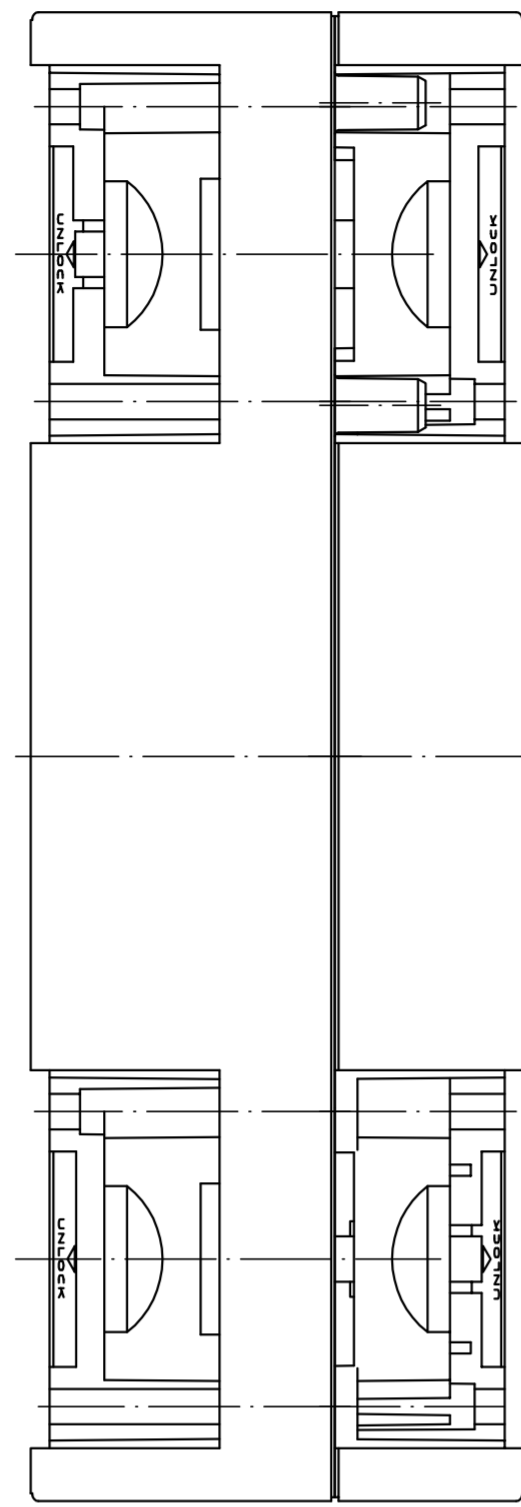

3

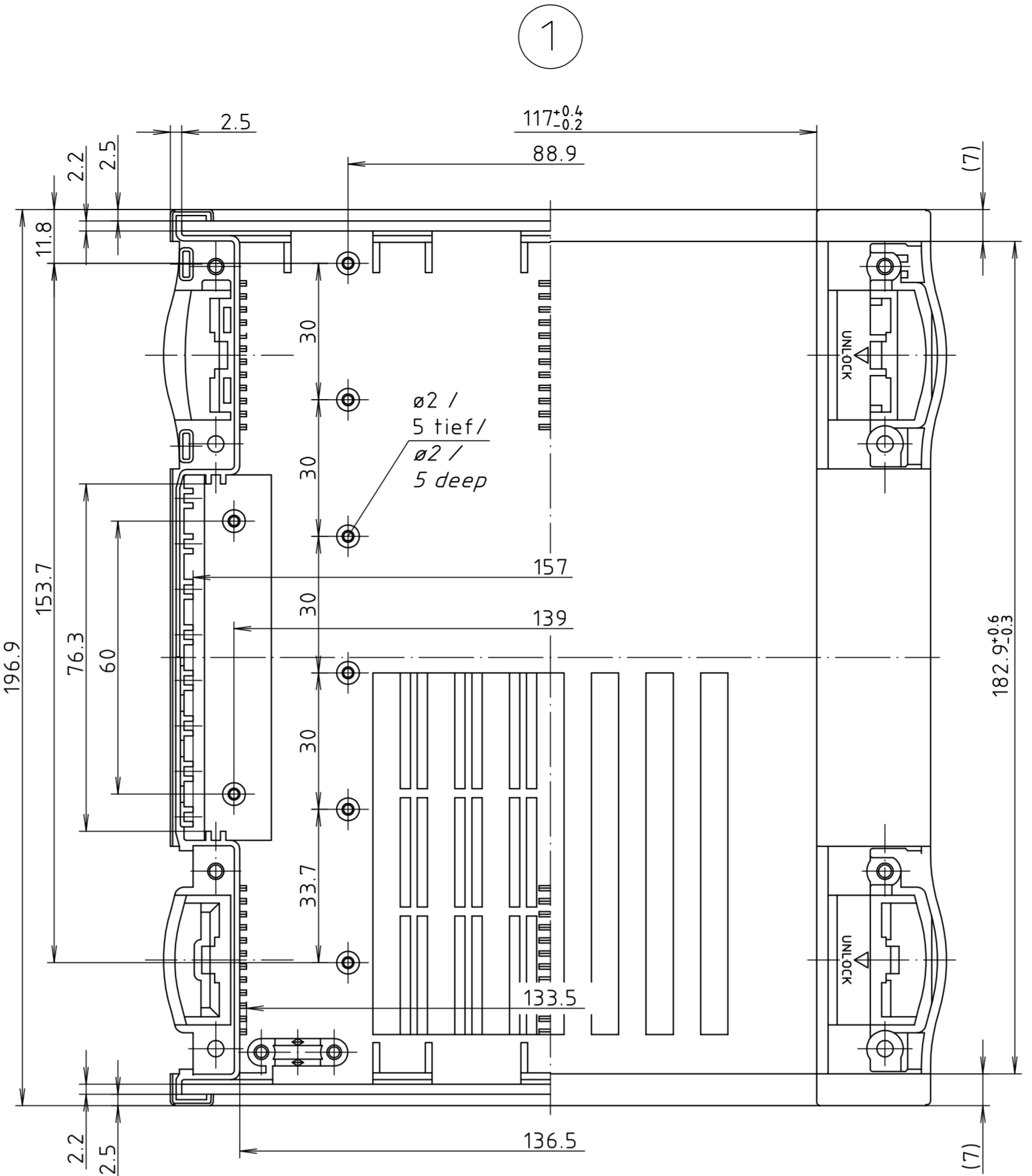

1

2

4

6

5

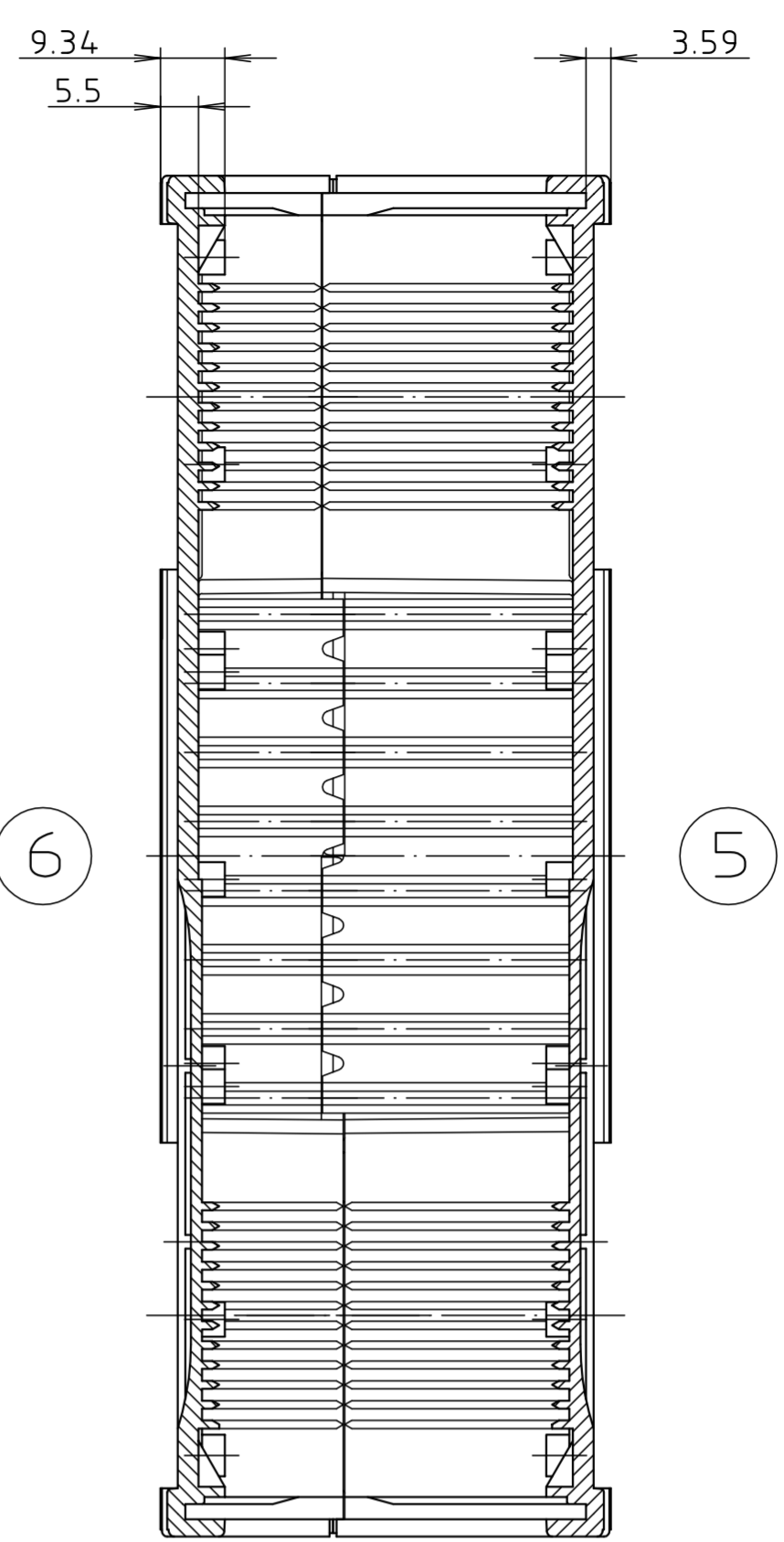

1:2

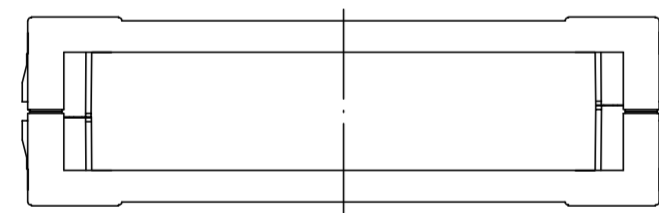

BO 32006 / BO 32006 L (Halbschale niedrig/niedrig)
BO 32006 / BO 32006 L (half shell low/low)

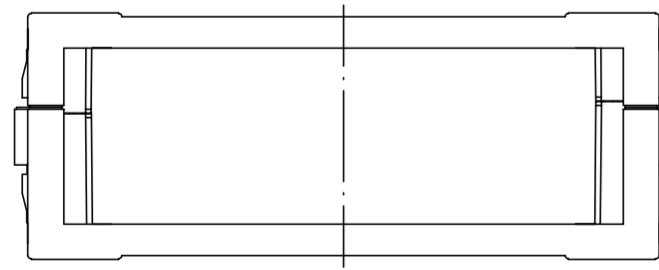

BO 32009 / BO 32009 L (Halbschale niedrig/hoch)
BO 32009 / BO 32009 L (half shell low/high)

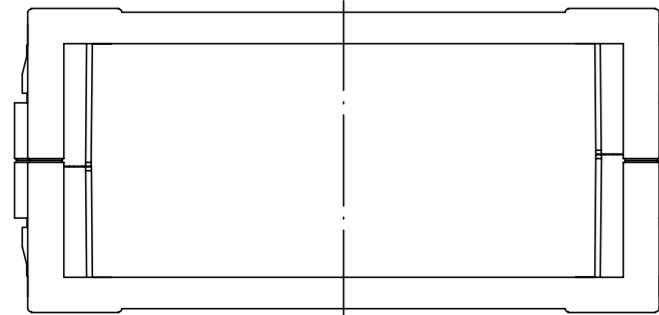

BO 32012 / BO 32012 L (Halbschale hoch/hoch)
BO 32012 / BO 32012 L (half shell high/high)

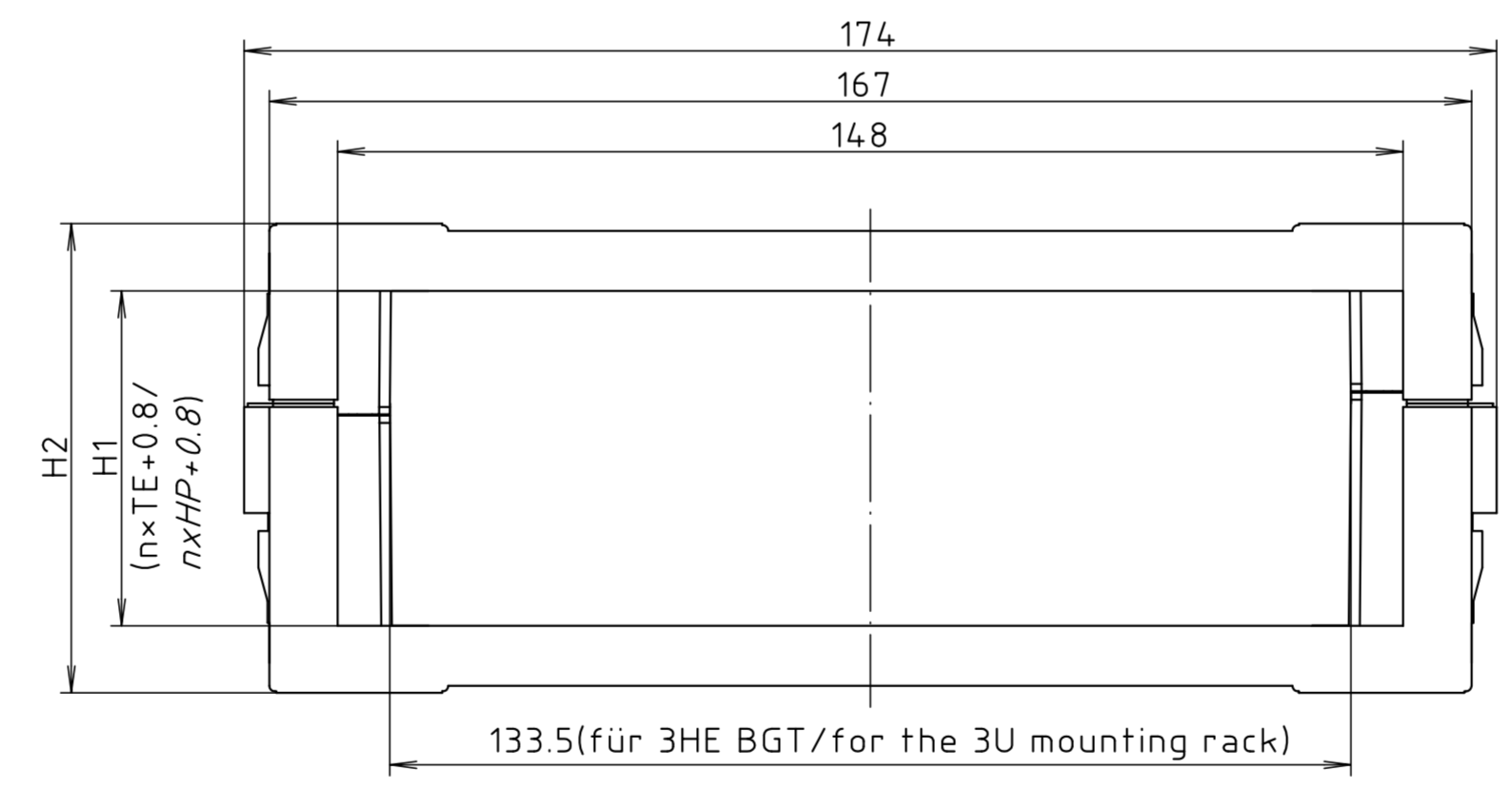

Modell / model	H1	H2	n
BO 32006 (L)	31.28	49.96	6
BO 32009 (L)	46.52	65.2	9
BO 32012 (L)	61.76	80.44	12

Maßstab / Scale: 1:1 (1:2)

Zeichnungs-Nr. / Drawing-No.: 1K 5305.059.02

Artikel / Article: BOTEGO BO 320.. (L)
Katalogzeichnung / Catalogue drawing

3618	07.08.2002
A-Nr. / Alt.-No.	Datum / Date

DISK: 2 802 020
Datum / Date: 04.07.2000 KH