

F 416-...

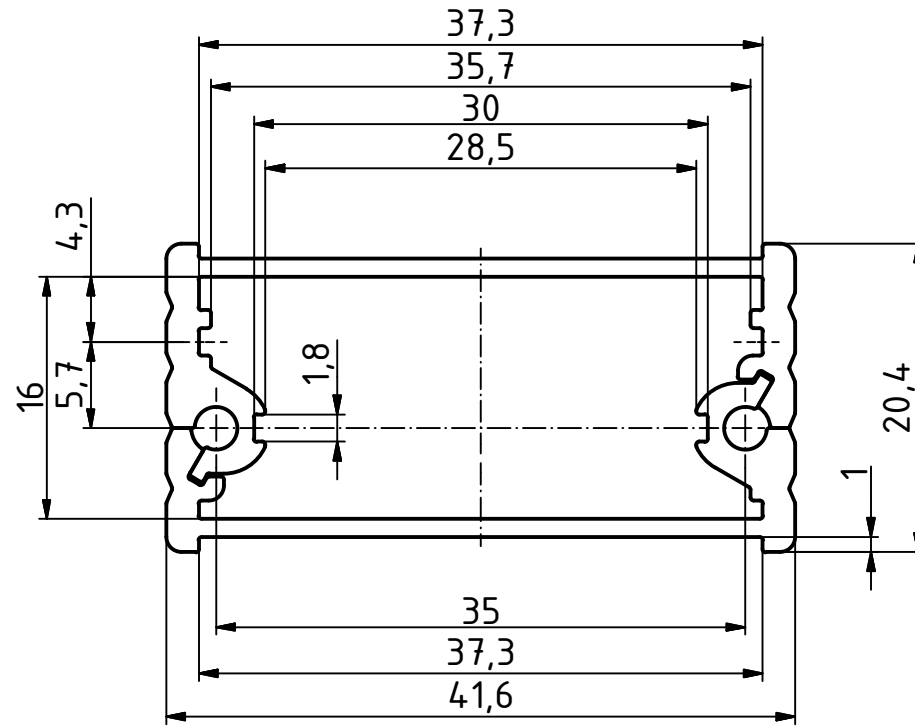

F 420-...

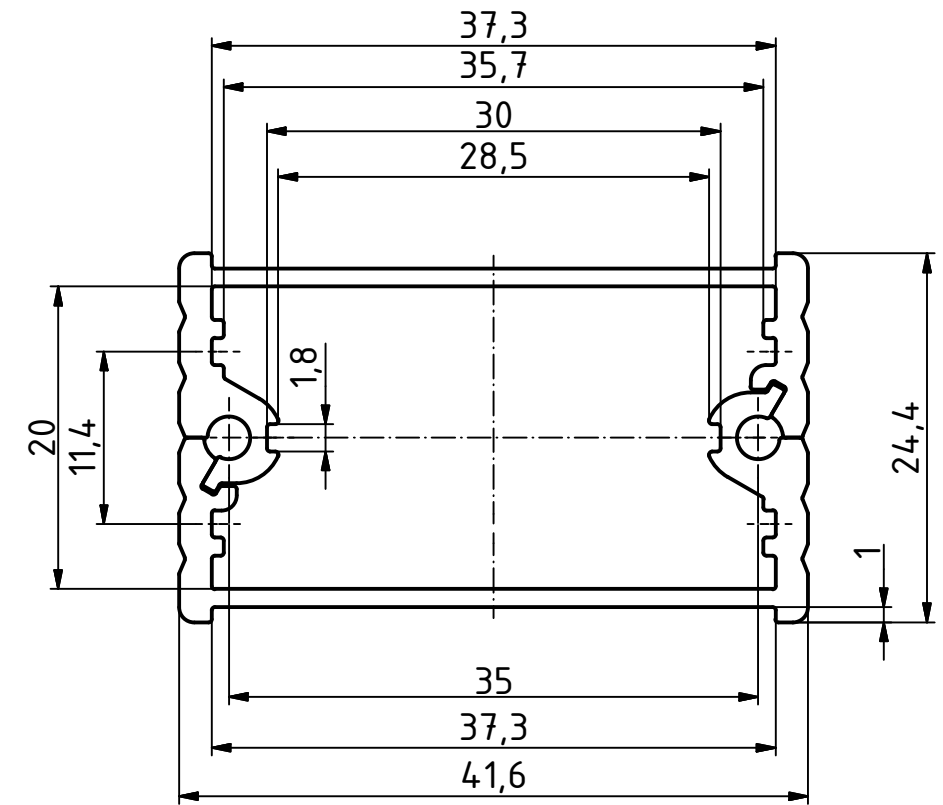

F 424-...

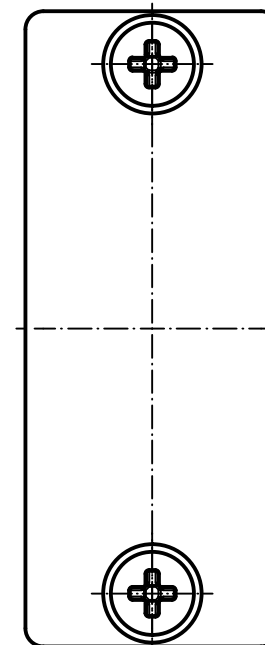
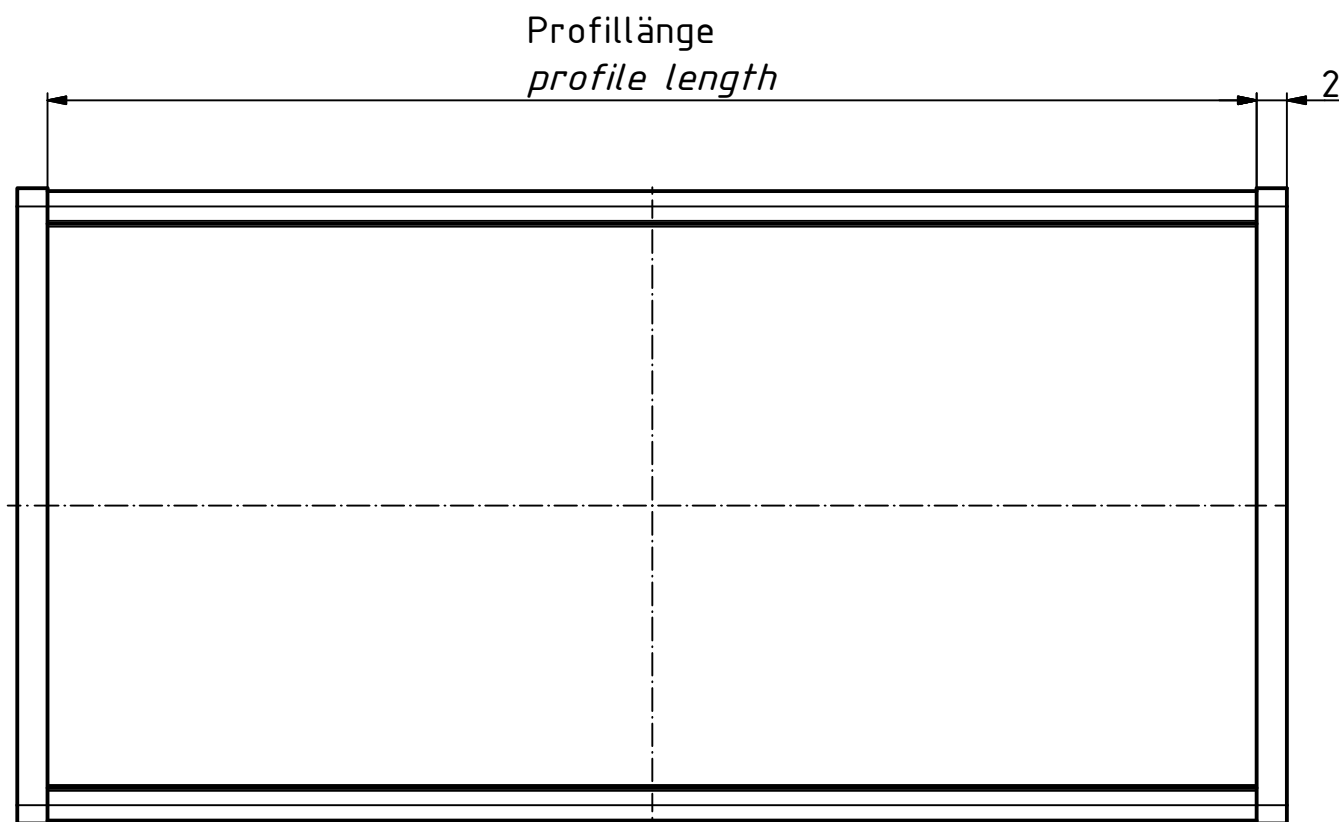

Maßstab/ Scale: 2:1		
Zeichnungs-Nr. / Drawing-No.: 3K 5405.028.01		
Artikel / Article: Filotec F 4..		
Katalogzeichnung / catalogue drawing		
Ä.Nr/ Alt.No:	Datum/ Date:	 BOPLA A Phoenix Mecano Company
DISK: 2803400.idw Datum/Date: 26.07.2012 FW		