

* = Mass durch Formkonizität nach unten verringert.
Freimass - Toleranz nach GTA 13/5 - DIN 1688

Deckel

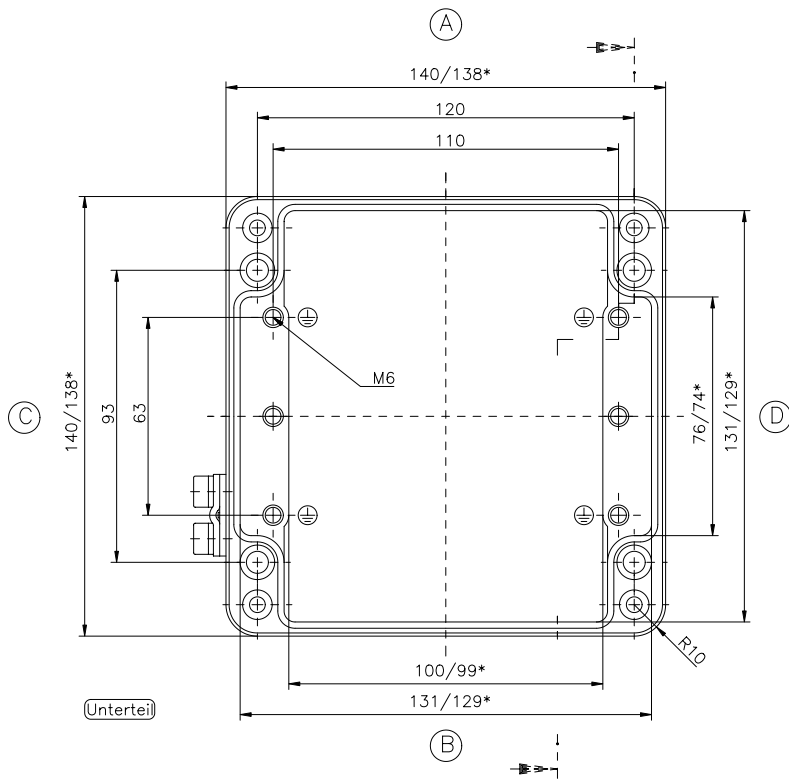

Unterteil

