

\* = Mass durch Formkonizität nach unten verringert.  
Freimass - Toleranz nach GTA 14/5 - DIN 1688

Deckel

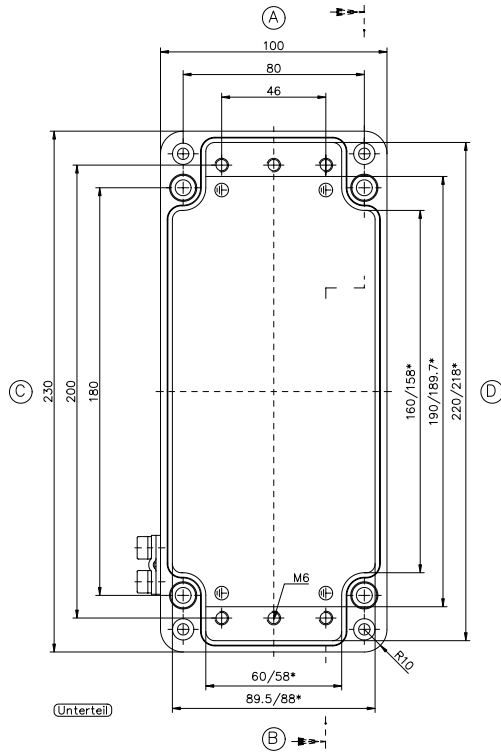

Unterteil

