

Zylinderschraube M8 DIN6912

Ansicht-A

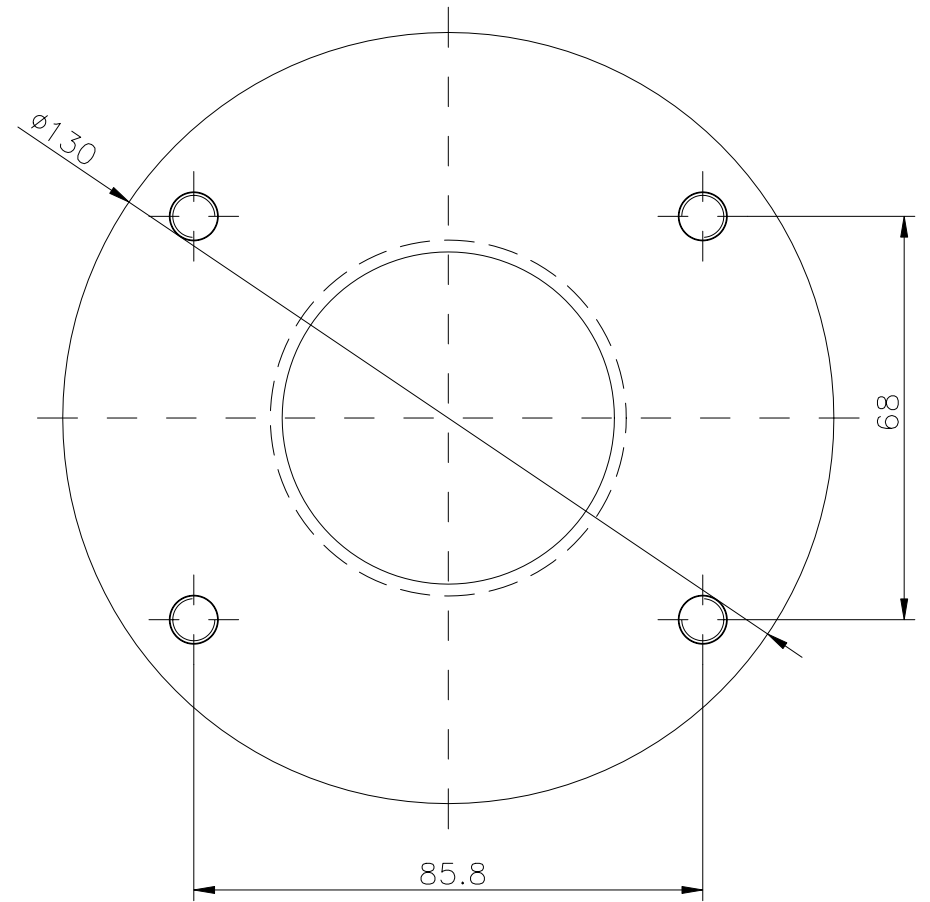

Aufsatzgelenk 2 GTH 60
Bestell-Nr. 57.026602